



OPERATING & ASSEMBLY INSTRUCTION

NAC3MPX-TOP & NAC3MPX-WOT-TOP powerCON® TRUE1 TOP | APPLIANCE INLET

OPERATING INSTRUCTION

Application:

The powerCON TRUE1 system is certified as a connector with breaking capacity according IEC 60320, VDE 0625. It is intended for use as an appliance coupler and interconnection coupler. It serves to supply power to an appliance and from an appliance to other equipment. To be installed by qualified person only.

CONNECTOR ASSIGNMENT:

APPLIANCE INLET

NAC3MPX-TOP
NAC3MPX-WOT-TOP
Power IN ▶



APPLIANCE OUTLET

NAC3FPX-TOP
NAC3FPX-WOT-TOP
NAC3FPX-ST-TOP
Power OUT ◀

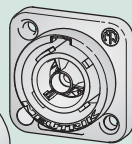

APPLIANCE INLET / OUTLET ▶ Combination

NAC3PX-TOP
Power IN ▶

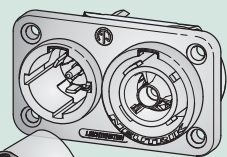

Power OUT ◀

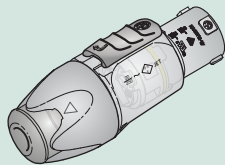

NAC3FX-W-TOP
(Connector)

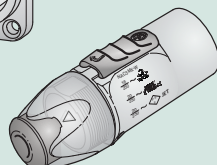

NAC3MX-W-TOP
(Plug connector)

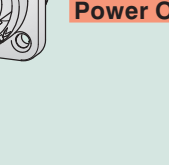

NAC3FX-W-TOP
(Connector)

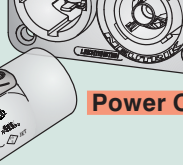
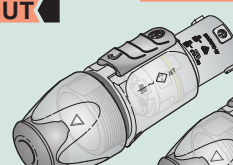

NAC3MX-W-TOP
(Plug connector)

powerCON TRUE1 TOP line is full backward compatible with the preceding powerCON TRUE1 products.

UL50E environmental rating

Enclosure Type 4 when installed with sealing cover SCNAC-MPX and cover closed or when mated with cord connector NAC3FX-W-TOP.

ASSEMBLY INSTRUCTION

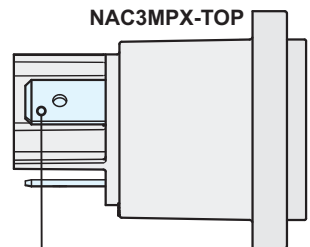
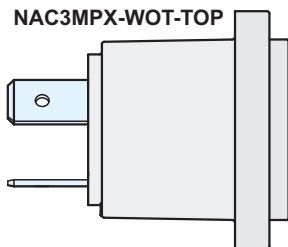

Flat tabs for 1/4" FASTON®

WIRING

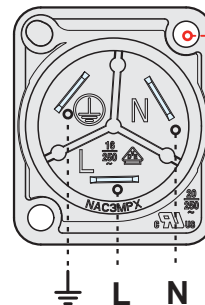

Attention:
Tightening torque
 $M_A = 40 \text{ Ncm}$.

Panel Cutout (Rear Side)

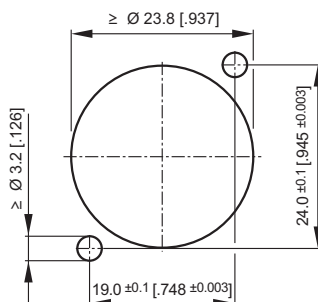

Find more details of powerCON TRUE1 TOP on www.neutrik.com.

Neutrik AG LI T: +423 / 237 24 24 F: +423/232 53 93
 Neutrik USA Inc. USA T: +1 704 / 972 3050 F: +1 704/438 9202
 Neutrik (UK) Ltd. UK T: +44 1983 / 811 441 F: +44 1983/811 439
 Neutrik Vertriebs GmbH DE/NL/AT/DK T: +49 8131 / 280 890 F: +49 8131/280 830

Neutrik France FR T: +33 1/4131 6750 F: +33 1/4131 0511
 Neutrik Tokyo Ltd. JP T: +81 3/3663 4733 F: +81 3/3663 4796
 Neutrik Hong Kong Ltd. HK T: +852/2687 6055 F: +852/2687 6052
 Neutrik India Pvt. Ltd. IND T: +91/982 05 43 424 F: +91/22 26163 540

Draft. Nr.: BDA 544 | Update: 11.07.2018 | Data subject to change without prior notice. © 2018 NEUTRIK®. NEUTRIK® are registered trademark of NEUTRI AG. ALL RIGHTS RESERVED.

www.neutrik.com

NEUTRIK®